

JOIN 80x140 cm

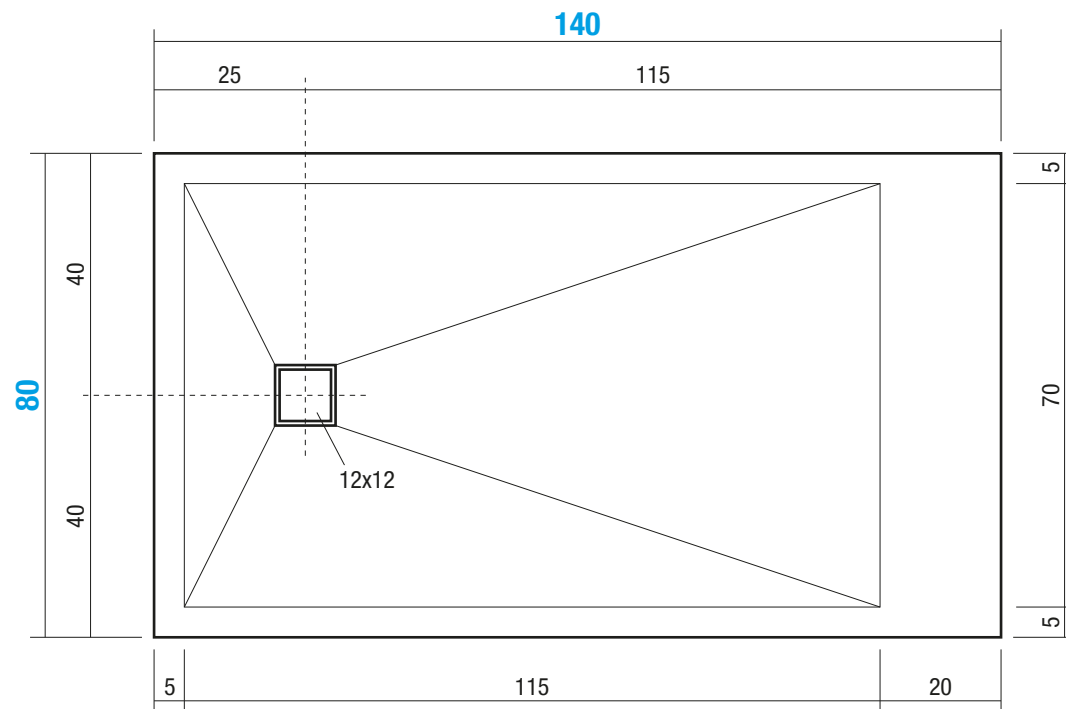

DISENIA®

ARCHITECTURAL SHOWERS

via A. Carpenè, 21 - 33070
Maron di Brugnera (PN) - Italy
Tel. +39 0422 742242 - Fax +39 0422 742067
www.disenia.it - e-mail: info@disenia.it

Articolo

Article / Article

JNAP80140

Materiale

Material / Matériel

TECNOGEL

Peso Netto

Net Weight / Poids net

52 Kg

Peso Lordo

Gross Weight / Poids brut

57 Kg

Dimensioni Imballo

Packaging Dimensions / Dimensions d'emballage

161x88 cm H.10

Volume Imballo

Packaging Volume / Volume d'emballage

0,15 m³

QUESTO DISEGNO È DI PROPRIETÀ ESCLUSIVA DELLA DISENIA PROTETTO DALLE VIGENTI LEGGI, NON PUÒ ESSERE RIPRODOTTO O CEDUTO A TERZI SENZA AUTORIZZAZIONE SCRITTA DELLA STESSA

THIS DRAWING IS THE EXCLUSIVE PROPERTY OF DISENIA PROTECTED BY APPLICABLE LAWS, IT CANNOT BE REPRODUCED OR GIVEN TO THIRD PARTIES WITHOUT DISENIA'S WRITTEN AUTHORIZATION.

DISENIA EST LA SEULE PROPRIÉTAIRE DE CE DESSIN, PROTÉGÉ PAR LE LOIS APPLICABLES, IL NE PEUT PAS ÊTRE REPRODUIT OU DONNÉ À UN TIERS SANS L'AUTORISATION ÉCRITE DE L'ENTREPRISE.

Pre-Installazione / Pre-Installation Indications / Indications Pre-Installation

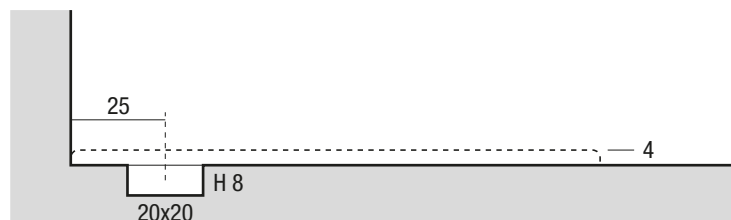

Nr. Cartucce consigliate per la posa del piatto

Nr. of Cartridges suggested for installation
Numero des Cartouches sugerees pour l'installation

x 2

