

ONDA-FM4B 80x180,1/210 cm

DIN 51097
Ramp test for barefoot



CLASS A

Ramp angle
≥ 12°

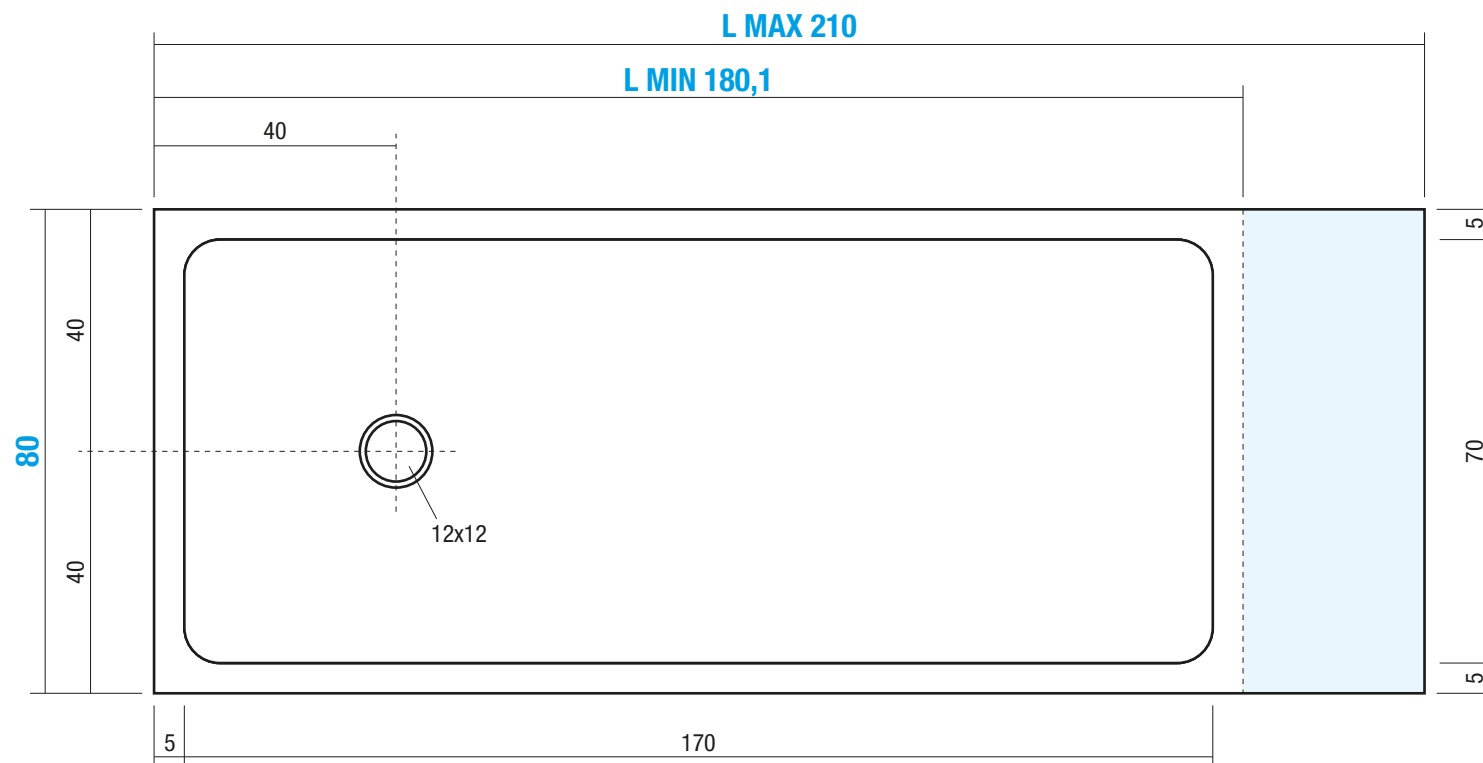

DISENIA®

ARCHITECTURAL SHOWERS

via A. Carpenè, 21 - 33070
Maron di Brugnera (PN) - Italy
Tel. +39 0422 742242 - Fax +39 0422 742067
www.disenia.it - e-mail: info@disenia.it

Articolo

Article / Article

ONDA80FM4B

Materiale

Material / Matériel

AQUATEK

Peso Netto

Net Weight / Poids net

45.7 Kg

Peso Lordo

Gross Weight / Poids brut

51.5 Kg

Dimensioni Imballo

Packaging Dimensions / Dimensions d'emballage

222x87 cm H.8

Volume Imballo

Packaging Volume / Volume d'emballage

0,3 m³

QUESTO DISEGNO È DI PROPRIETÀ ESCLUSIVA DELLA DISENIA PROTETTO DALLE VIGENTI LEGGI, NON PUÒ ESSERE RIPRODOTTO O CEDUTO A TERZI SENZA AUTORIZZAZIONE SCRITTA DELLA STESSA

THIS DRAWING IS THE EXCLUSIVE PROPERTY OF DISENIA PROTECTED BY APPLICABLE LAWS, IT CANNOT BE REPRODUCED OR GIVEN TO THIRD PARTIES WITHOUT DISENIA'S WRITTEN AUTHORIZATION.

DISENIA EST LA SEULE PROPRIÉTAIRE DE CE DESSIN, PROTÉGÉ PAR LE LOIS APPLICABLES, IL NE PEUT PAS ÊTRE REPRODUIT OU DONNÉ À UN TIERS SANS L'AUTORISATION ÉCRITE DE L'ENTREPRISE.

Pre-Installazione / Pre-Installation Indications / Indications Pre-Installation

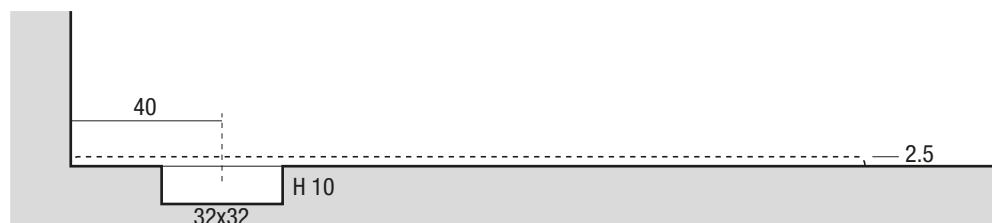

Nr. Cartucce consigliate per la posa del piatto

Nr. of Cartridges suggested for installation
Numero des Cartouches sugerees pour l'installation

x 3

