

# ONDA 80x80 cm

DIN 51097  
Ramp test for barefoot



CLASS A

Ramp angle  
≥ 12°

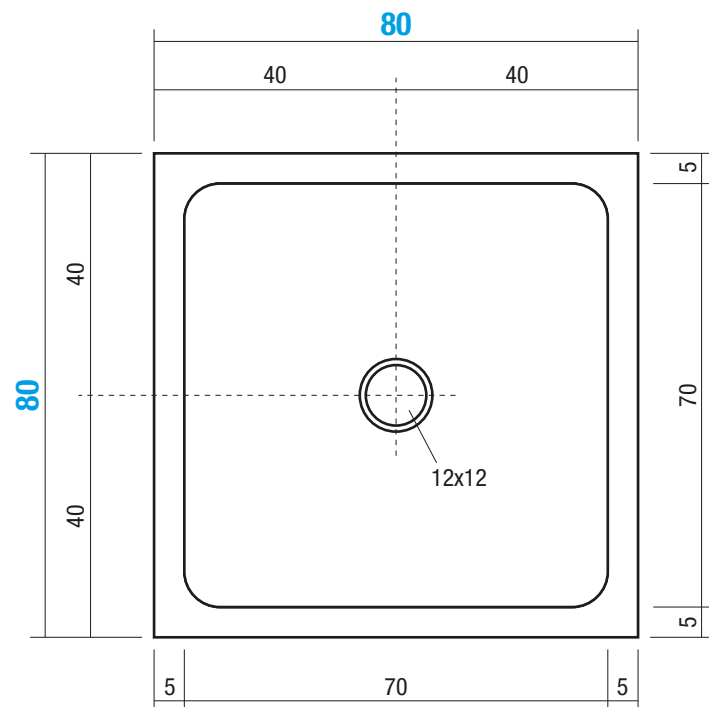

Pre-Installazione / Pre-Installation Indications / Indications Pre-Installation

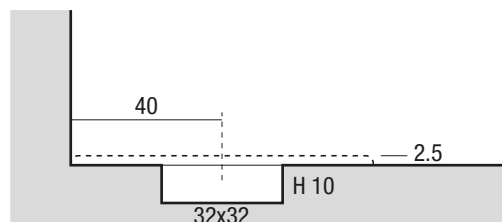

Nr. Cartucce consigliate per la posa del piatto

Nr. of Cartridges suggested for installation  
Numero des Cartouches sugerees pour l'installation

x 1

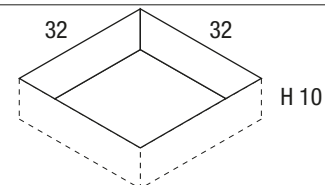

# DISENIA®

ARCHITECTURAL SHOWERS

via A. Carpenè, 21 - 33070  
Maron di Brugnera (PN) - Italy  
Tel. +39 0422 742242 - Fax + 39 0422 742067  
[www.disenia.it](http://www.disenia.it) - e-mail: info@disenia.it

Articolo  
Article / Article

**ONDA8080TP**

Materiale  
Material / Matériel

**AQUATEK**

Peso Netto  
Net Weight / Poids net

**18 Kg**

Peso Lordo  
Gross Weight / Poids brut

**23 Kg**

Dimensioni Imballo  
Packaging Dimensions / Dimensions d'emballage

**92x87 cm H.8**

Volume Imballo  
Packaging Volume / Volume d'emballage

**0,15 m<sup>3</sup>**

QUESTO DISEGNO È DI PROPRIETÀ ESCLUSIVA DELLA DISENIA PROTETTO DALLE VIGENTI LEGGI, NON PUÒ ESSERE RIPRODOTTO O CEDUTO A TERZI SENZA AUTORIZZAZIONE SCRITTA DELLA STESSA

THIS DRAWING IS THE EXCLUSIVE PROPERTY OF DISENIA PROTECTED BY APPLICABLE LAWS, IT CANNOT BE REPRODUCED OR GIVEN TO THIRD PARTIES WITHOUT DISENIA'S WRITTEN AUTHORIZATION.

DISENIA EST LA SEULE PROPRIÉTAIRE DE CE DESSIN, PROTÉGÉ PAR LE LOIS APPLICABLES, IL NE PEUT PAS ÊTRE REPRODUIT OU DONNÉ À UN TIERS SANS L'AUTORISATION ÉCRITE DE L'ENTREPRISE.