

**KRUS** 100x100 cm

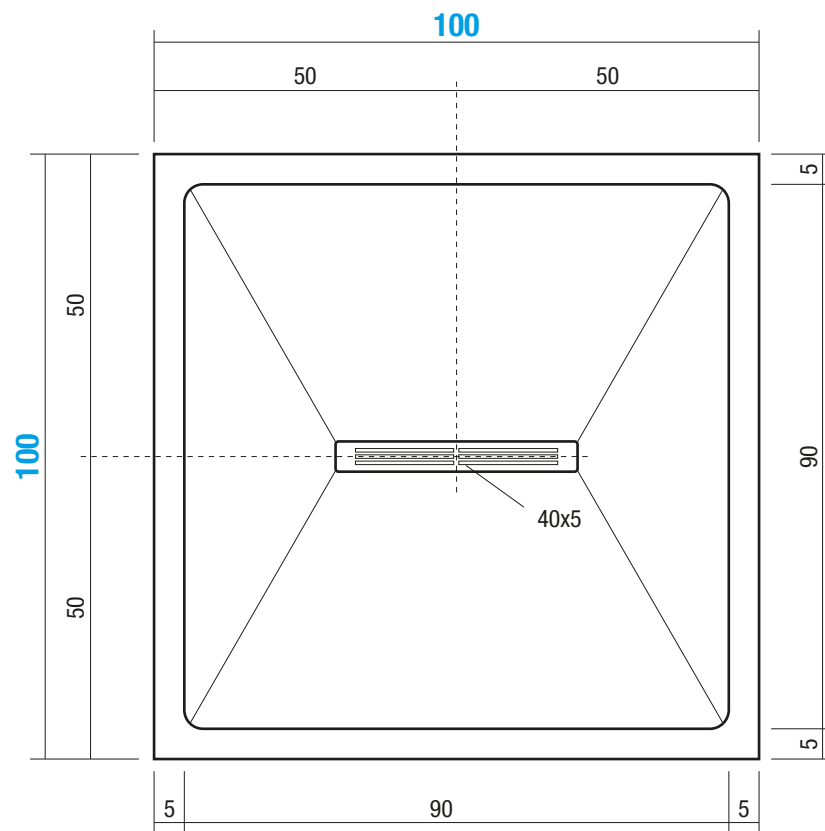

**Pre-Installazione** / Pre-Installation Indications / Indications Pre-Installation

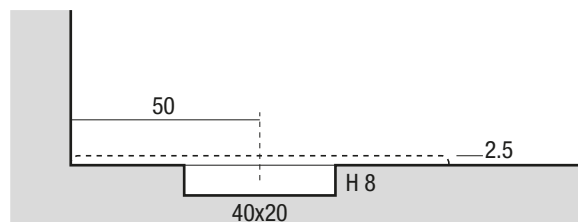

**Nr. Cartucce consigliate per la posa del piatto**

Nr. of Cartridges suggested for installation  
Numero des Cartouches sugerees pour l'installation

**x 2**

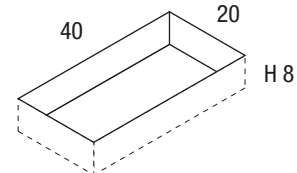

**DISENIA**<sup>®</sup>

ARCHITECTURAL SHOWERS

via A. Carpenè, 21 - 33070  
Maron di Brugnera (PN) - Italy  
Tel. +39 0422 742242 - Fax + 39 0422 742067  
[www.disenia.it](http://www.disenia.it) - e-mail:info@disenia.it

**Articolo**

Article / Article

**KR100100**

**Materiale**

Material / Matériel

**TECNOGEL**

**Peso Netto**

Net Weight / Poids net

**39 Kg**

**Peso Lordo**

Gross Weight / Poids brut

**44 Kg**

**Dimensioni Imballo**

Packaging Dimensions / Dimensions d'emballage

**121x108 cm H.10**

**Volume Imballo**

Packaging Volume / Volume d'emballage

**0,15 m<sup>3</sup>**

QUESTO DISEGNO È DI PROPRIETÀ ESCLUSIVA DELLA DISENIA PROTETTO DALLE VIGENTI LEGGI, NON PUÒ ESSERE RIPRODOTTO O CEDUTO A TERZI SENZA AUTORIZZAZIONE SCRITTA DELLA STESSA

THIS DRAWING IS THE EXCLUSIVE PROPERTY OF DISENIA PROTECTED BY APPLICABLE LAWS, IT CANNOT BE REPRODUCED OR GIVEN TO THIRD PARTIES WITHOUT DISENIA'S WRITTEN AUTHORIZATION.

DISENIA EST LA SEULE PROPRIÉTAIRE DE CE DESSIN, PROTÉGÉ PAR LE LOIS APPLICABLES, IL NE PEUT PAS ÊTRE REPRODUIT OU DONNÉ À UN TIERS SANS L'AUTORISATION ÉCRITE DE L'ENTREPRISE.