

RILIEVO MISURE E COMPILAZIONE MODULO D/05

INDICARE LE QUOTE, IL VERSO (SX O DX) E LA TIPOLOGIA DI MONTAGGIO (APPOGGIO O A FILO PAVIMENTO)

DISENIA[®]
ARCHITECTURAL SHOWERS

DISENIA S.R.L.
Via A. Carpenè, 21 - 33070 - Maron di Brugnera (PN)
Tel. +39 0422 742242 - Fax + 39 0422 742067
www.disenia.it ideagroup@ideagroup.it info@disenia.it

Data Modello Rivenditore

Note Installatore

CONSIGLIAMO DI ALLEGARE UNA FOTO DELLO SPAZIO INTERESSATO

VERSO **SX**

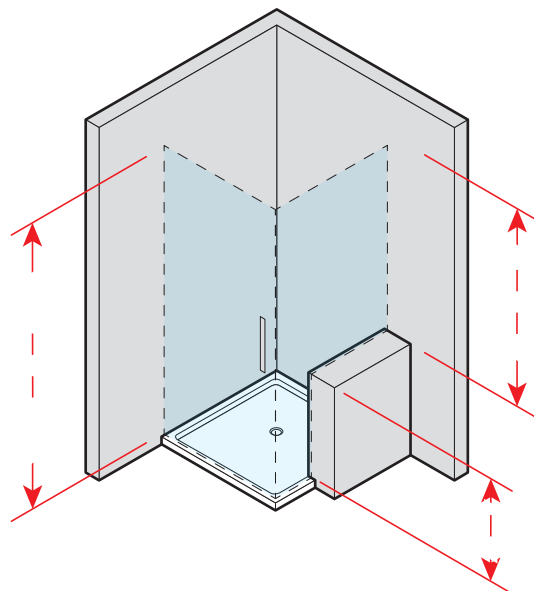
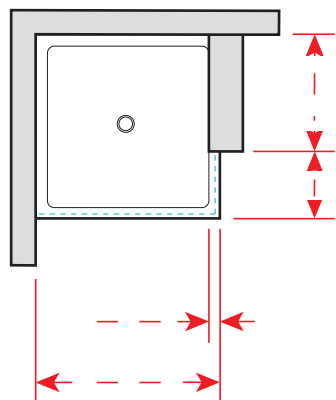

APPOGGIO

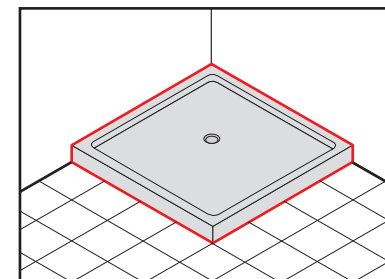

MONTAGGIO STANDARD

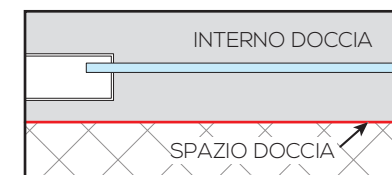

FILO PAVIMENTO

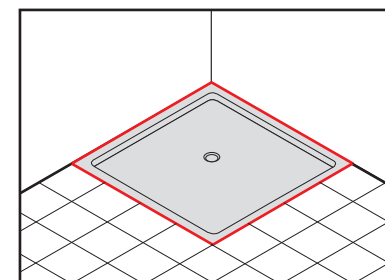

MONTAGGIO PROFILO ALL'INTERNO

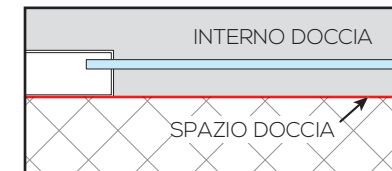

MONTAGGIO PROFILO ALL'ESTERNO

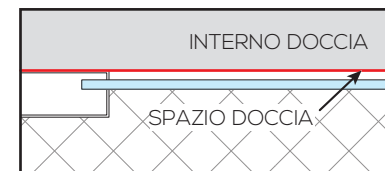

MONTAGGIO VETRO ALL'INTERNO

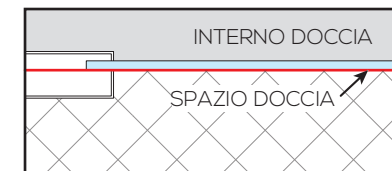

MONTAGGIO VETRO ALL'ESTERNO FUGA

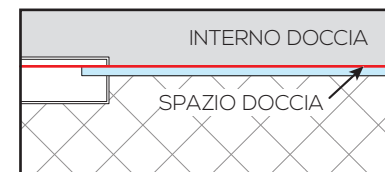

MONTAGGIO VETRO SU MEZZARIA FUGA



VERSO **DX**

